

Foodservice Equipment • Material Handling, Healthcare & Cleanroom Equipment • Retail Display

Item #: _____ Qty.: _____
Model #: _____ Project #: _____

Mop Sink

Floor Mount

Optional Accessories	Model #	Qty.
Service Faucet		
Hose and bracket		
3-Pole mop holder		
4-Pole mop holder		



- ◆ floor mount design for the ultimate in sanitation
- ◆ all stainless steel construction provides long life and easy maintenance
- ◆ superior to other material finishes
- ◆ exclusive anti-splash double-offset "V" edge prevents spillage
- ◆ deep drawn seamless sink bowl with 8" water level
- ◆ full range of accessories

Spec sheets available for viewing, printing or downloading from our online literature library at www.eaglegrp.com

For custom configuration or fabrication needs, contact our **SpecFAB Division**.
Phone: (302) 653-3000. FAX: (302) 653-3091.
E-mail: specfab@eaglegrp.com



design & construction features

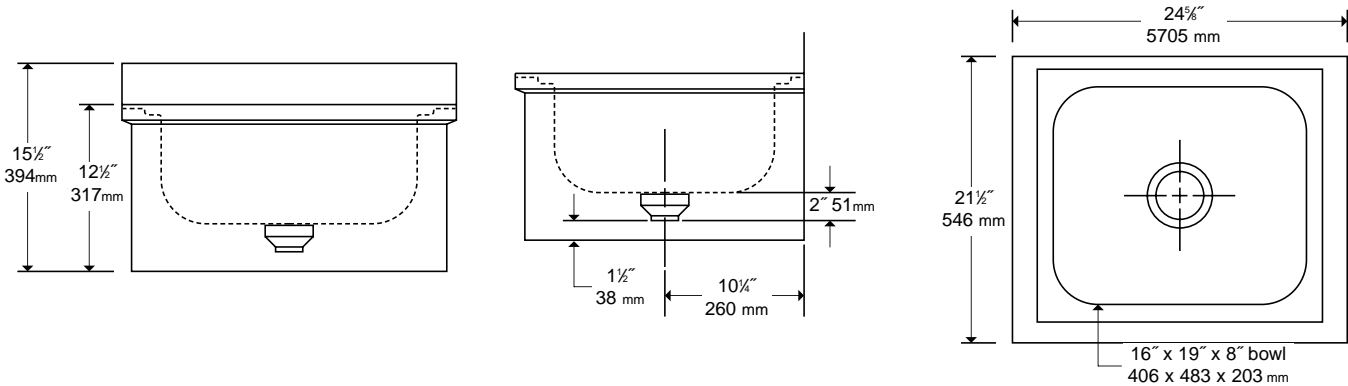

construction features

- ◆ entire top assembly is fused, welded and planished providing a one-piece seamless floor sink
- ◆ welded areas are high-speed belt blended to match adjacent surfaces with continuity of satin finish
- ◆ stainless steel skirt is stud-bolted to underside of top in a concealed manner providing a clean visual appearance

mechanical

- ◆ water supply is 1/2" IPS for hot and cold lines
- ◆ wall-mount faucet's are available as options
- ◆ drain is 2" IPS cast brass

material

- ◆ top – 16 gauge type 304 stainless steel
- ◆ sink bowl – 18 gauge type 304 stainless steel
- ◆ skirt – 18 gauge type 304 stainless steel

design features

- ◆ a superior floor sink designed for institutional use as well as those installations which require quality and durability
- ◆ sink bowl is deep-drawn one piece seamless construction using state-of-the-art hydraulic presses
- ◆ exclusive anti-splash double-offset "V" edge prevents spillage
- ◆ sink bowl has a generous radius with a minimum dimension of 3" and is rectangular for maximum capacity
- ◆ 8" water level — 8 3/4" flood level
- ◆ full skirt allows for tight sanitary seal
- ◆ drain is 2" IPS cast brass with removable flat strainer plate

size (W x L)		model #	shipping	
in.	mm		lbs.	kg.
21 1/2 x 24 3/4	546 X 625	F1916	35	15.9

accessories

description	size	model #	shipping	
			lbs.	kg.
service faucet	8" center	312690	11	5.0
hose & bracket	30" (L)	312689	8	3.6
3-pole mop holder	14" x 3/8" x 1 1/2" and projects out 1 1/2"	312688	4	1.8
4-pole mop holder	24" x 1" x 4"	321561	4.5	2.0



4-pole mop holder

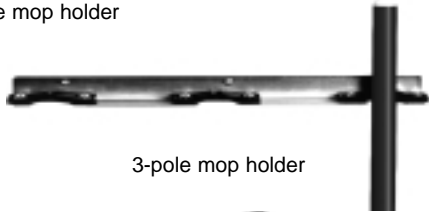

3-pole mop holder



hose and bracket



service faucet